

PARTS LIST

MODEL:MC5200

PARTS LIST

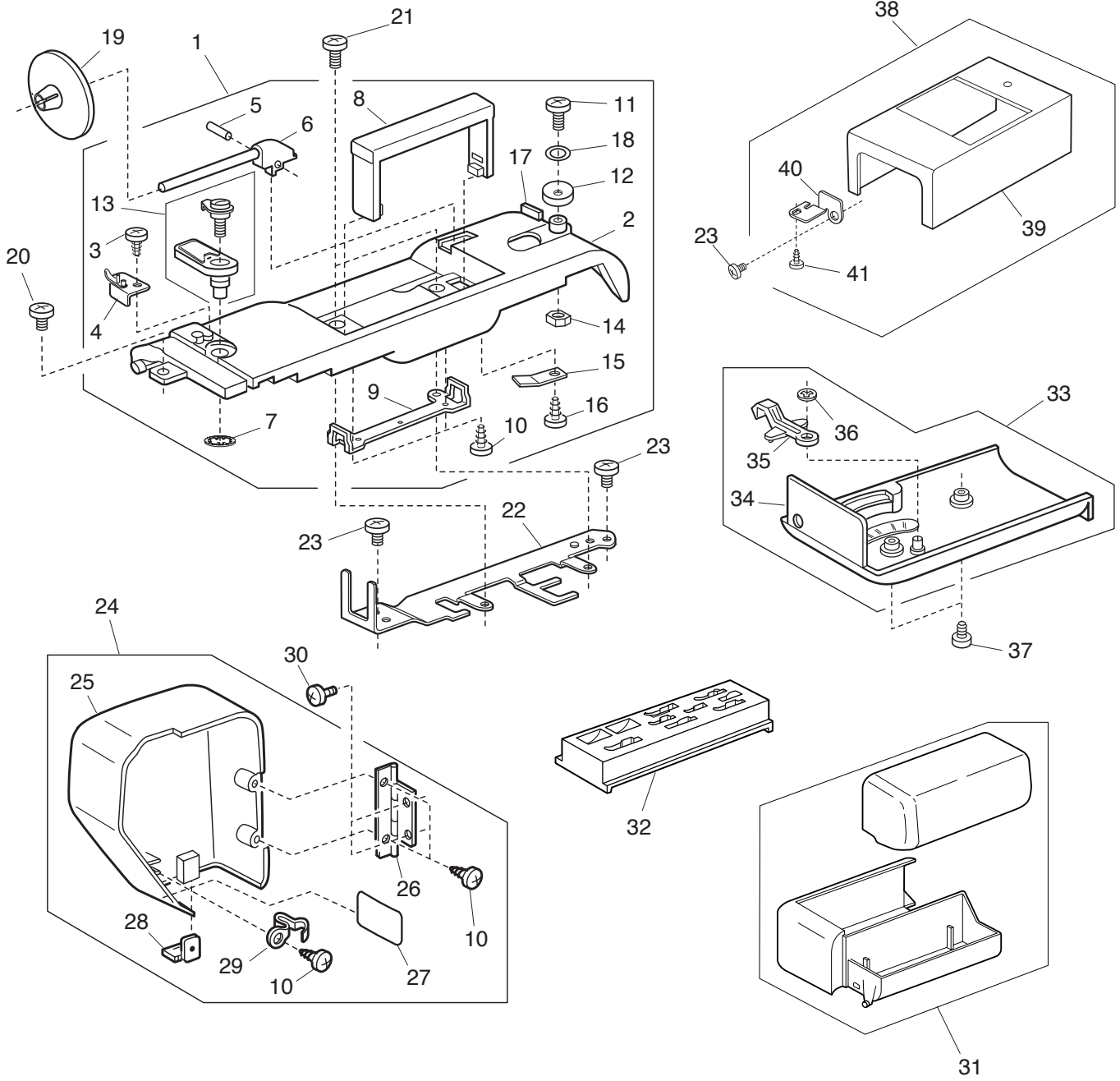

PARTS LIST

KEY NO.	PARTS NO.	DESCRIPTION
1	844645106	Top cover (unit)
2	828008042	Top cover
3	000162001	Setscrew 2.6x5 (B)
4	827503005	Top cover thread guide (unit)
5	822017002	Spool pin shaft
6	724206106	Spool pin
7	000014409	Snap ring CS-8
8	827014004	Handle
9	827015005	Set plate
10	000161206	Setscrew 3x10 (B)
11	000103107	Setscrew 4x14
12	735016307	Bobbin winder stopper
13	650503702	Thread guide (unit)
14	000061205	Nut 4-3-7
15	724207004	Spool pin spring
16	000107318	Setscrew 3x8 (B)
17	840602408	Thread cutter (unit)
18	000071013	Washer 4
19	822020503	Spool holder (large)
20	810220106	Setscrew
21	000103107	Setscrew 4x14
22	844078009	Top cover set plate
23	000101404	Setscrew 4x6
24	844613404	Face plate (unit)
25	844033301	Face plate
26	366501102	Face plate hinge (unit)
27	827099003	Face plate sticker
28	840602006	Thread cutter (unit)
29	731067002	Face plate spring
30	000081119	Setscrew 4x6
31	844503008	Extension table (unit)
32	827009109	Foot case
33	827602108	Bed cover (unit)
34	827004104	Bed cover
35	753005000	Drop lever
36	000013903	Snap ring CS-5
37	000101703	Setscrew 4x12
38	659601007	Free arm cover (unit)
39	659001001	Free arm cover
40	756004008	Free arm cover set plate
41	000120203	Setscrew 3x8 (B)

PARTS LIST

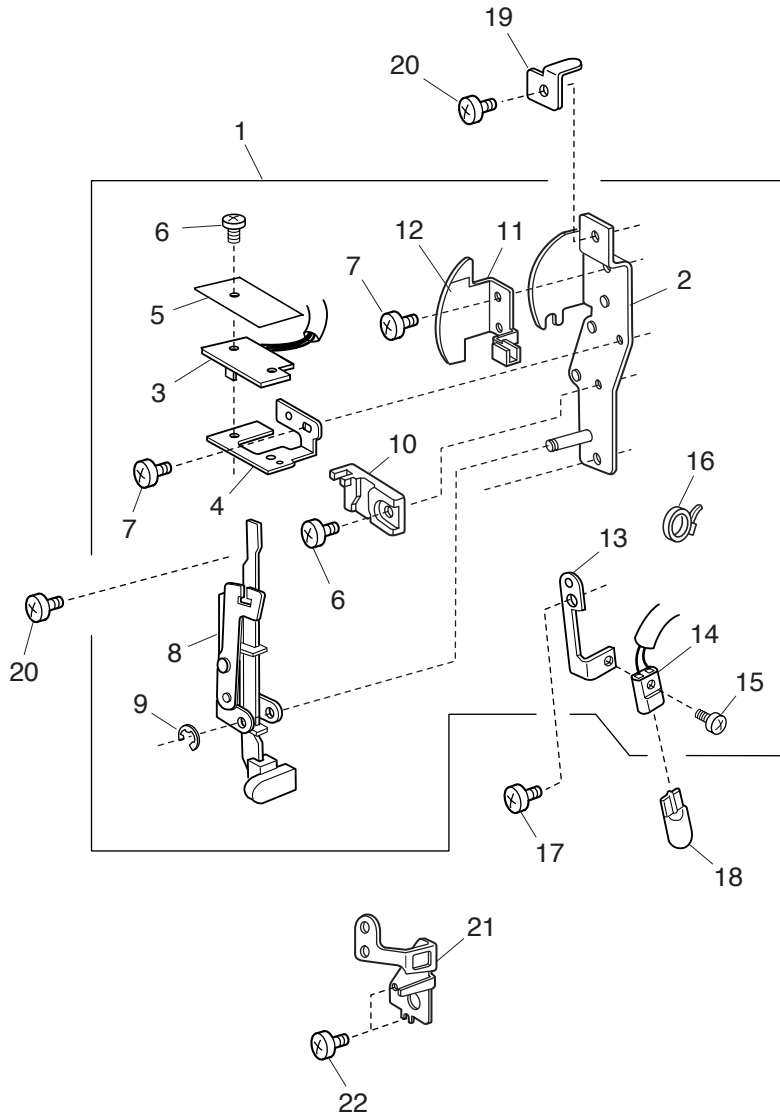

PARTS LIST

KEY NO.	PARTS NO.	DESCRIPTION
1	844640008	Front set plate (unit)
2	844096003	Front set plate
3	843502004	Printed circuit board E-1 (unit)
4	844040013	Buttonhole sensor set plate
5	845029008	Insulation paper
6	000103808	Setscrew 3x5
7	000097406	Setscrew 3x3
8	843625107	Buttonhole lever (unit)
9	000002105	Snap ring E-3
10	830057010	Buttonhole lever guide
11	842038001	Cord guide plate
12	829016002	Sticker
13	843055007	Lamp set plate
14	843508000	Lamp socket (unit)
15	000102900	Setscrew 2x8
16	000053008	Cord binder
17	000101105	Setscrew 3x4
18	000026002	Wedge base lamp 12V 5W
19	827106004	Presser bar bushing set plate
20	810220106	Setscrew
21	843038004	Lamp set plate
22	000101507	Setscrew 3.5x5

PARTS LIST

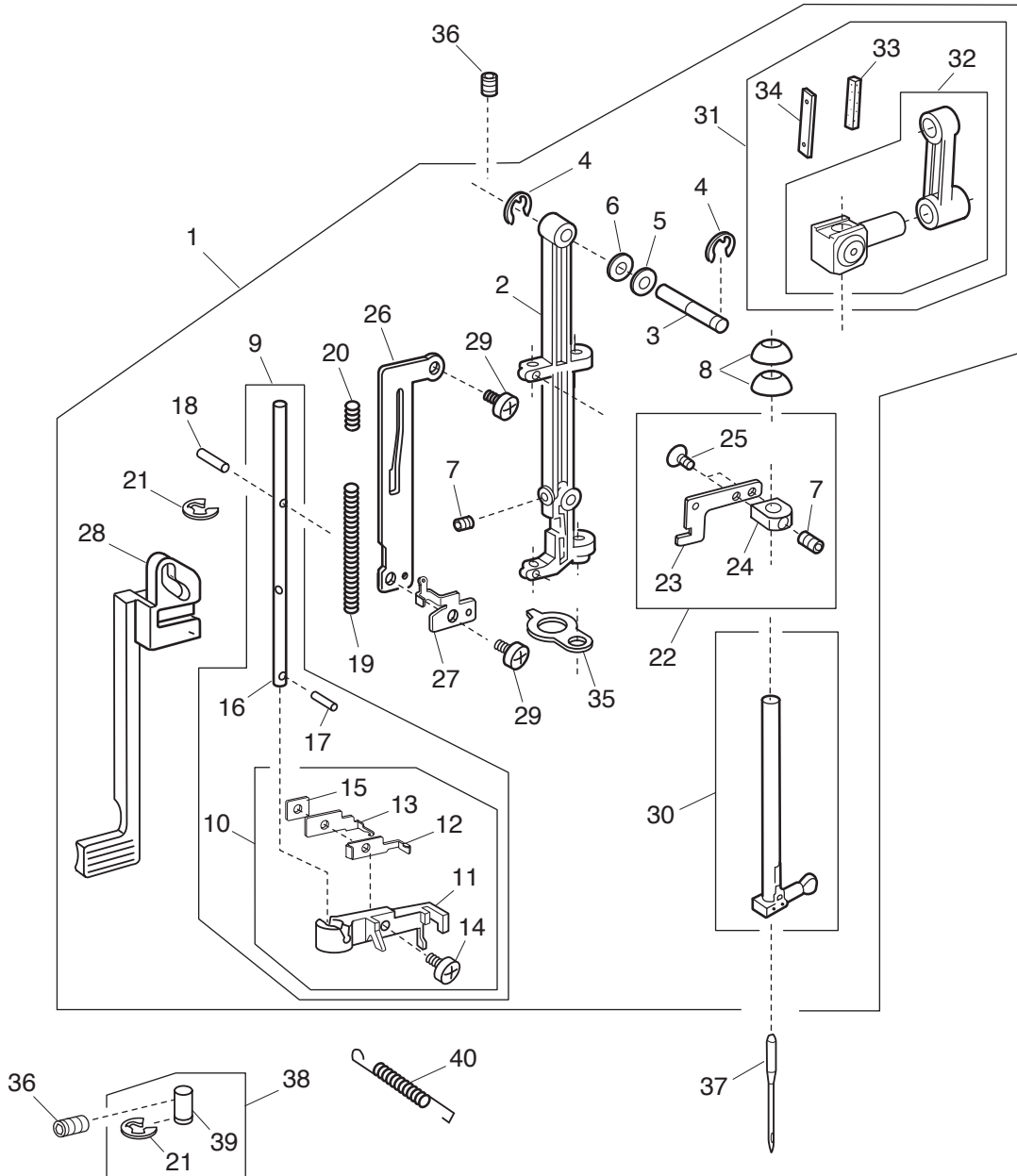

PARTS LIST

KEY NO.	PARTS NO.	DESCRIPTION
1	842636005	Needle bar supporter (unit)
2	827026010	Needle bar supporter
3	730022002	Needle bar supporter pin
4	000002507	Snap ring E-4
5	000070609	Washer
6	673022002	Spring washer
7	000111902	Hexagonal socket screw 3x4
8	827098002	Washer
9	842637006	Threader shaft (unit)
10	842638007	Threader plate (unit)
11	755064106	Threader guard plate
12	842088006	Thread retension plate
13	844095002	Threader plate
14	755096004	Setscrew
15	755095003	Nut
16	840036025	Threader shaft
17	000003508	Spring pin 2x8
18	000125105	Guide pin E-2x16-CH
19	842090001	Threader shaft spring
20	842096007	Threader lever spring
21	000002105	Snap ring E-3
22	842622008	Threader positioning setting plate (unit)
23	842053002	Threader positioning setting plate
24	734102009	Threader positioning setting block
25	000097602	Setscrew 2x4
26	842091002	Threader guide plate
27	844036027	Threader lever plate
28	842092003	Threader lever
29	000078319	Setscrew 3x6
30	653503309	Needle bar (unit)
31	653612003	Needle bar connecting stud (unit)
32	653504001	Needle bar connecting stud (unit)
33	650040005	Felt
34	650041006	Spring
35	829027006	Supporter guide plate
36	000111201	Hexagonal socket screw 4x4
37	102408089	Needle HAx3N-14
38	842625001	Supporter guide pin (unit)
39	827083004	Pin
40	844038018	Supporter spring

PARTS LIST

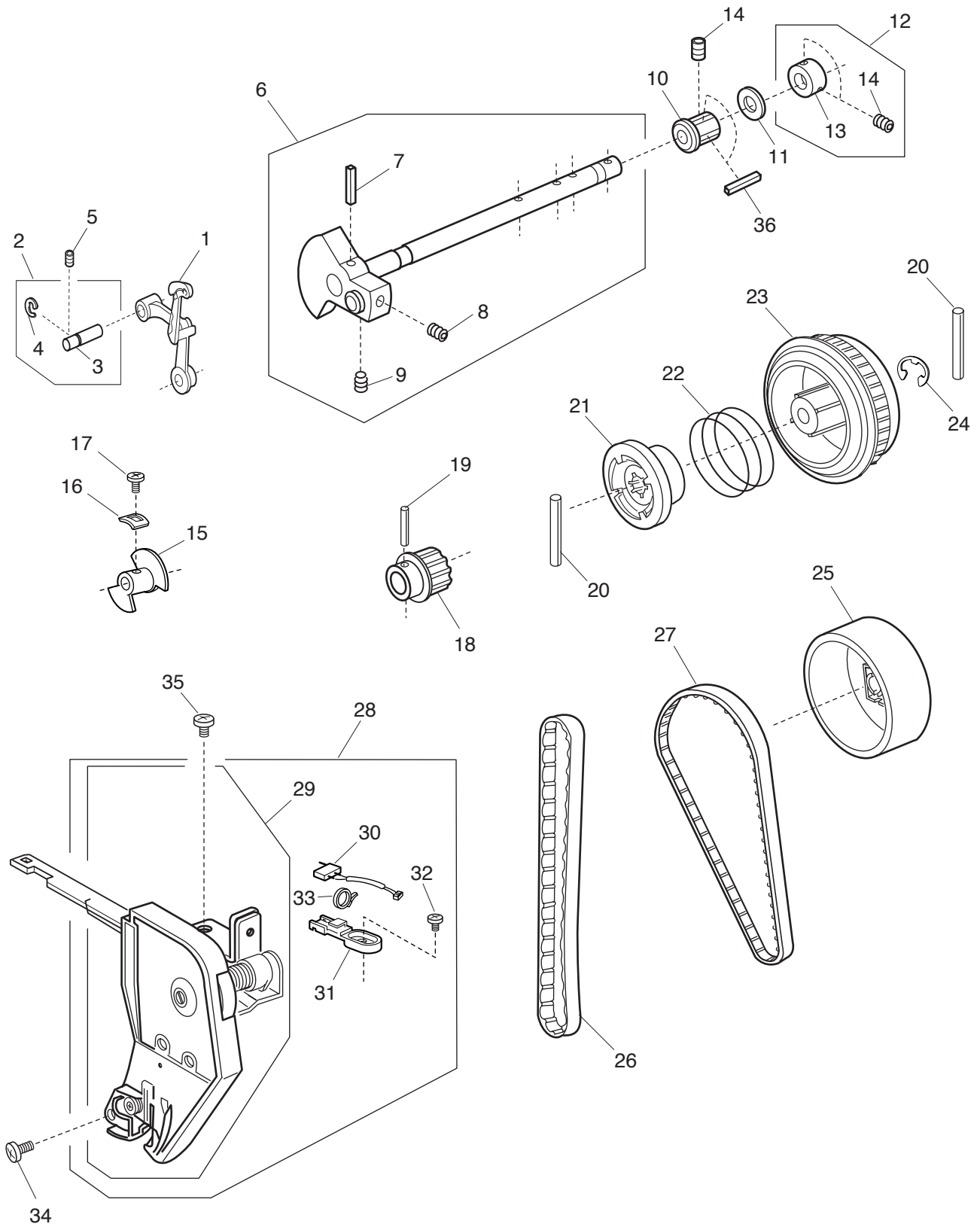

PARTS LIST

KEY NO.	PARTS NO.	DESCRIPTION
1	820511108	Thread take-up lever (unit)
2	650626001	Thread take-up lever pin (unit)
3	650062003	Thread take-up lever pin
4	000001702	Snap ring E-6
5	000111201	Hexagonal socket screw 4x4
6	844505000	Upper shaft (unit)
7	000021708	Spring pin 4x22
8	000110901	Hexagonal socket screw 5x4
9	000111706	Hexagonal socket screw 5x8
10	829042007	Upper shaft front bushing
11	000038605	Washer
12	673642004	Upper shaft ring (unit)
13	673063016	Upper shaft ring
14	000111304	Hexagonal socket screw 5x5
15	830095010	Upper shaft shield plate
16	820102009	Washer
17	000081005	Setscrew 4x8
18	756017004	Upper shaft gear
19	000020501	Spring pin 3x22
20	000024206	Spring pin 3x30
21	502064003	Clutch ring
22	502065004	Clutch spring
23	844050016	Belt wheel
24	000030205	Snap ring E-8
25	844077008	Handwheel
26	650071005	Timing belt
27	653139012	Timing belt
28	844621209	Thread tension (unit)
29	844519100	Thread tension (unit)
30	753507708	Buttonhole select switch (unit)
31	827100008	Switch set plate
32	000103808	Setscrew 3x5
33	000053008	Cord binder
34	000101703	Setscrew 4x12
35	000101404	Setscrew 4x6
36	731384008	Felt

PARTS LIST

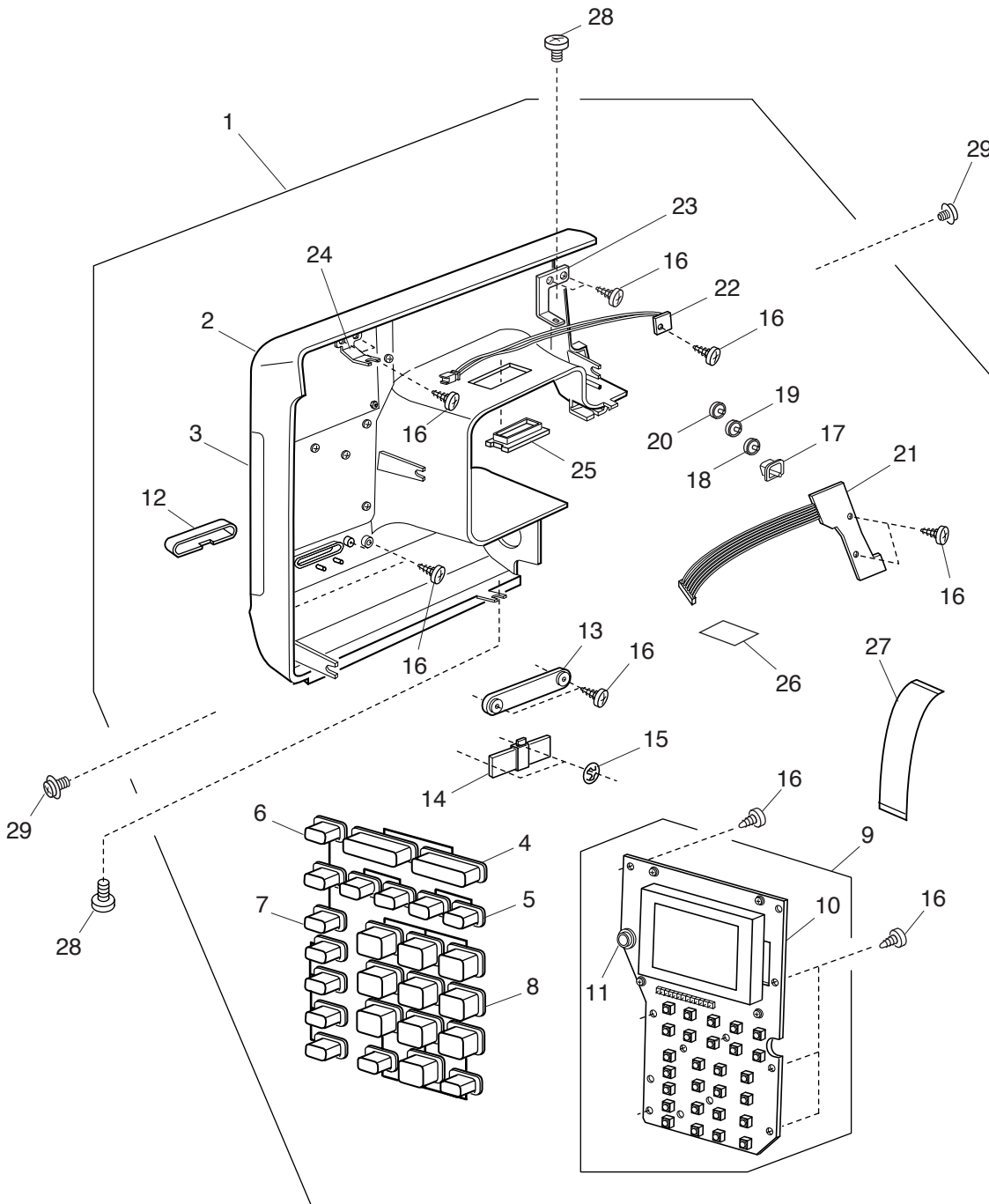

PARTS LIST

KEY NO.	PARTS NO.	DESCRIPTION
1	844647201	Front cover (unit)
2	844648202	Front cover (unit)
3	844055309	Touch panel
4	844056104	Button (1)
5	844057002	Button (2)
6	844058003	Button (3)
7	844059118	Button (4)
8	844060215	Button (5)
9	844626019	Printed circuit board K (unit)
10	844506012	Printed circuit board K (unit)
11	844066004	Adjusting dial
12	844104005	Slide volume
13	751273005	Slide volume knob
14	653507163	Slide volume (unit)
15	000014306	Snap ring CS-3
16	000120203	Setscrew 3x8 (B)
17	844068202	Start/stop button
18	844069306	Button (1)
19	844069203	Button (1)
20	844069100	Button (1)
21	844507002	Printed circuit board F (unit)
22	844516004	Printed circuit board L (unit)
23	842014001	Front cover setting plate (front)
24	844070001	Front cover setting plate (right)
25	851056106	Lamp cover
26	844109000	Caution sticker
27	844512000	Flexible cable
28	000101404	Setscrew 4x6
29	000115205	Setscrew TP 4x6

PARTS LIST

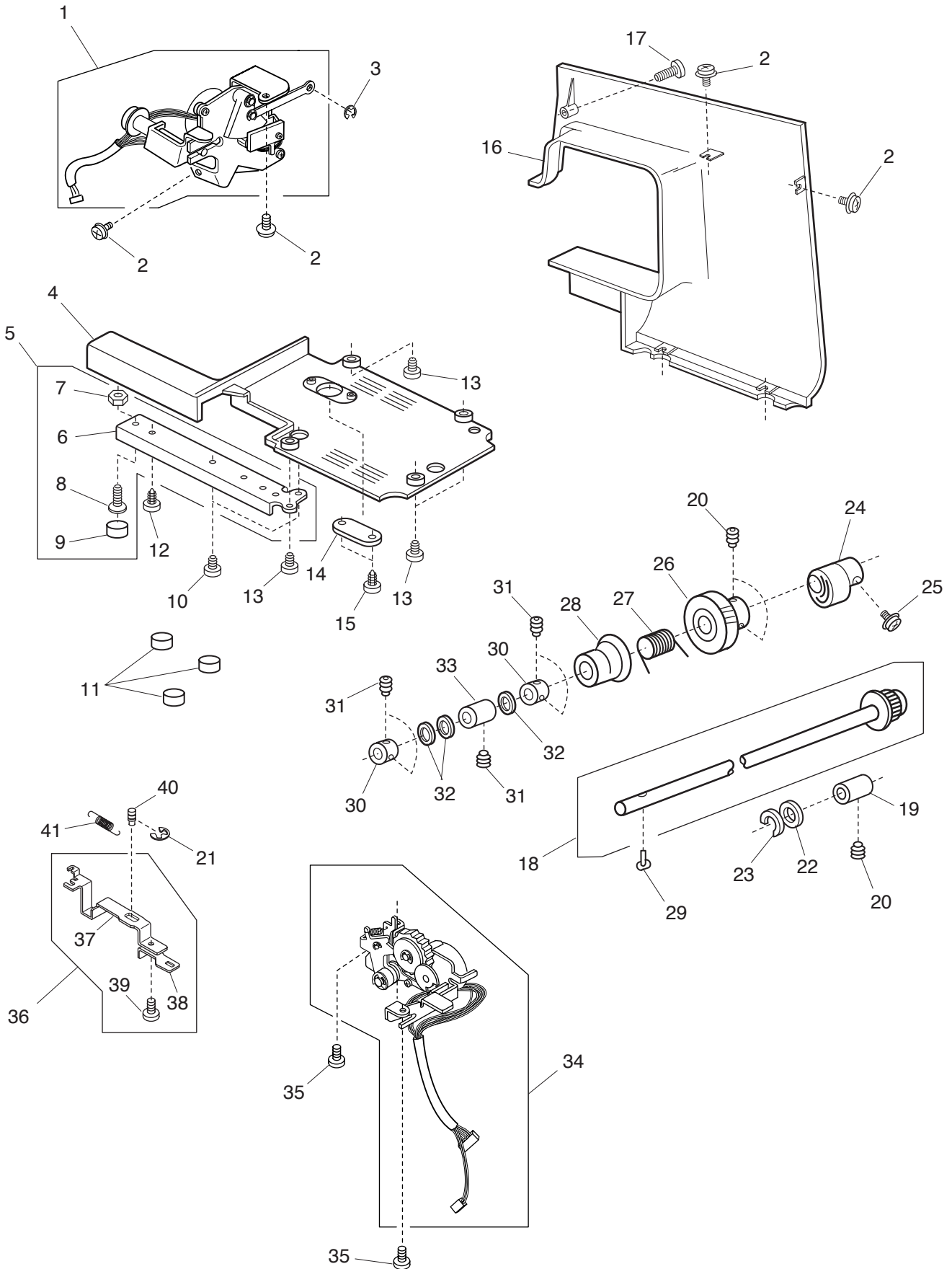

PARTS LIST

KEY NO.	PARTS NO.	DESCRIPTION
1	844602019	Feed motor (unit)
2	000115205	Setscrew TP 4x6
3	000002105	Snap ring E-3
4	827003000	Base plate
5	827601107	Arm leg (unit)
6	827002102	Arm leg
7	000061412	Nut 5-3-8
8	000097901	Setscrew 5x18
9	735002001	Rubber base
10	000066808	Setscrew 6x14
11	647009002	Bed rubber base
12	000120203	Setscrew 3x8 (B)
13	000103509	Setscrew 4x10
14	824058001	Base cover
15	000107318	Setscrew 3x8
16	842001108	Rear cover
17	000104119	Setscrew 4x20
18	827613009	Lower shaft (unit)
19	650079003	Lower shaft bushing (rear)
20	000111304	Hexagonal socket screw 5x5
21	000001207	Snap ring E-2.5
22	822070003	Felt
23	822112008	Felt holder (1)
24	823026111	Feed cam
25	000149600	Setscrew 3x14
26	650076000	Lower shaft gear
27	686035008	Feed lifting cam spring
28	753183025	Feed lifting cam
29	820161006	Feed lifting pin
30	820166001	Ring
31	000111201	Hexagonal socket screw 4x4
32	000038502	Washer
33	650078002	Lower shaft bushing (front)
34	844607014	Needle plate motor (unit)
35	000104005	Setscrew 3.5x8
36	844610010	Needle plate driving plate (unit)
37	844021018	Needle plate driving plate
38	844022008	Needle plate adjusting plate
39	000101105	Setscrew 3x4
40	844023009	Needle plate driving plate guide pin
41	844024011	Driving plate spring

PARTS LIST

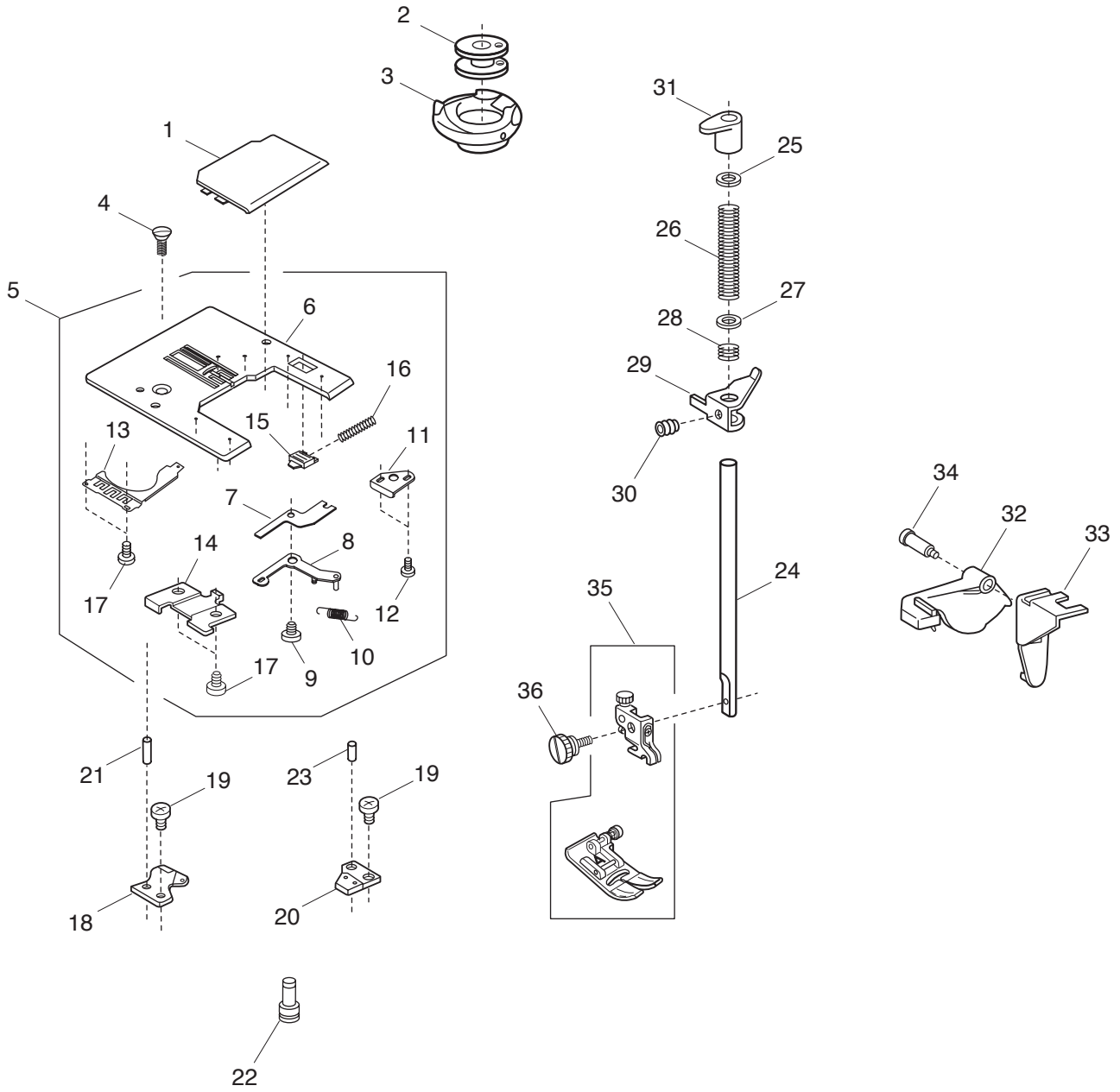

PARTS LIST

KEY NO.	PARTS NO.	DESCRIPTION
1	750036012	Hook cover plate
2	102261103	Bobbin
3	627569209	Bobbin holder (unit)
4	681009101	Needle plate setscrew
5	844612012	Needle plate (unit)
6	844630016	Needle plate (unit)
7	844029005	Needle plate lever washer
8	844030009	Needle plate lever
9	844031000	Needle plate lever screw
10	844032001	Needle plate lever spring
11	654078004	Rotation stopper
12	820373003	Setscrew 2x3
13	832235010	Hook cover plate holder (left)
14	825015010	Hook cover plate holder (right)
15	825016000	Hook cover plate holder release button
16	825017001	Hook cover plate holder spring
17	820374004	Setscrew 2x2.3
18	827011001	Bobbin holder stopper
19	810220106	Setscrew
20	627567001	Bobbin holder stopper (unit)
21	000122504	Pin D3x10CH
22	844002002	Needle plate positioning pin
23	000122700	Pin D2.5x6-LC
24	507086006	Presser bar
25	652201002	Washer
26	826006000	Presser bar spring
27	826055004	Washer
28	826056005	Support spring
29	735028003	Presser bar supporter
30	000111500	Hexagonal socket screw 4x8
31	652104004	Presser bar bushing
32	829013009	Presser foot pressure adjusting lever
33	829014000	Presser foot pressure adjusting plate
34	820090003	Setscrew
35	829515006	Presser foot (unit)
36	647112009	Setscrew

PARTS LIST

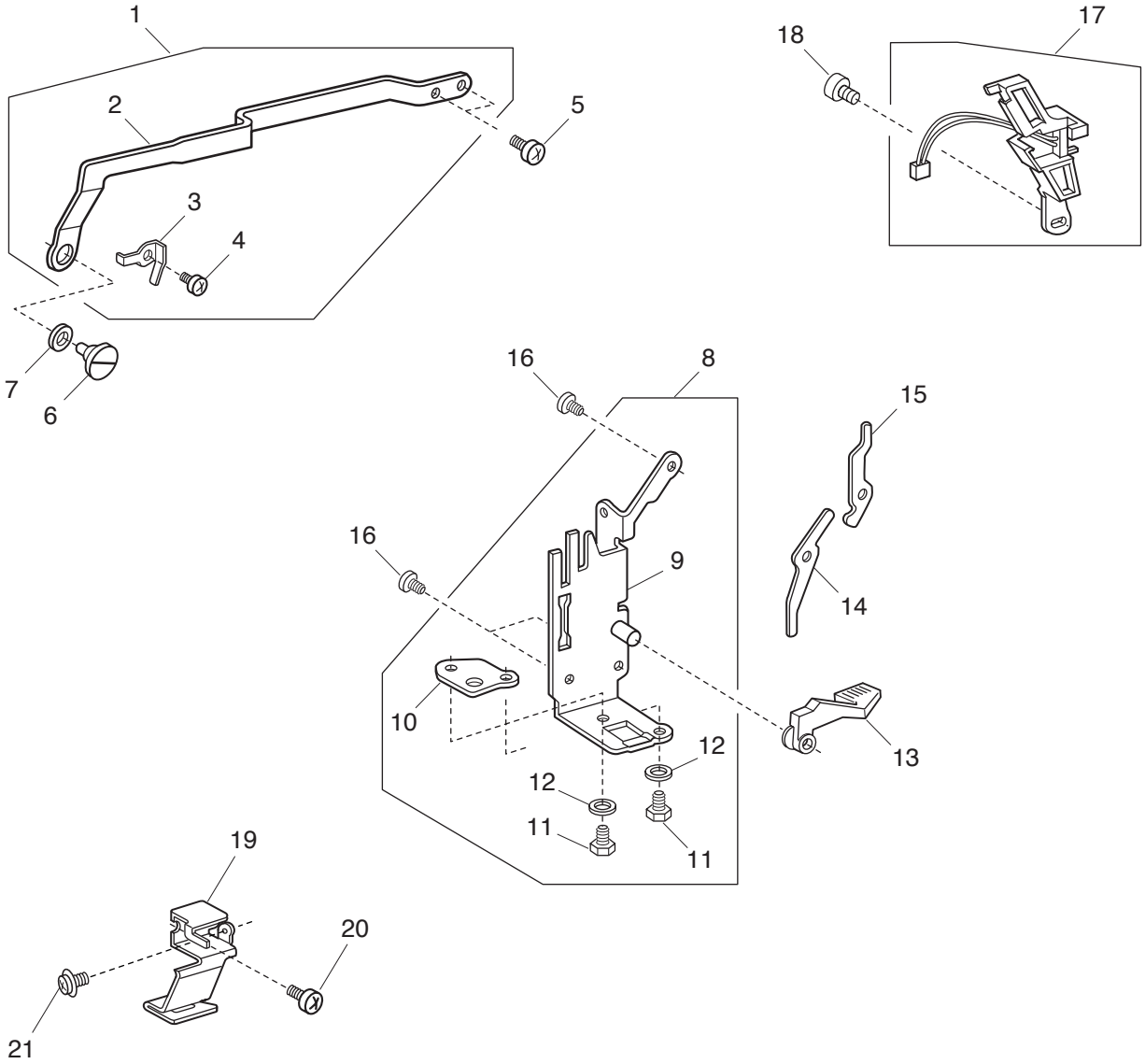

PARTS LIST

KEY NO.	PARTS NO.	DESCRIPTION
1	827622012	Zigzag width rod (unit)
2	827055018	Zigzag width rod
3	827088009	Zigzag width rod spring
4	820373003	Setscrew 2x3
5	000078319	Setscrew 3x6
6	678084007	Eccentric pin
7	653037008	Washer
8	827608207	Presser bar base plate (unit)
9	827020036	Presser bar base plate
10	827082003	Presser bar positioning plate
11	000066303	Hexagonal bolt 4x6
12	000070908	Washer
13	849052105	Presser foot lifter
14	827022005	Thread tension release lever (1)
15	827023006	Thread tension release lever (2)
16	000081005	Setscrew 4x8
17	840623106	Switch base (unit)
18	000103808	Setscrew 3x5
19	841010004	Arm thread guide
20	000101404	Setscrew 4x6
21	000115205	Setscrew TP 4x6

PARTS LIST

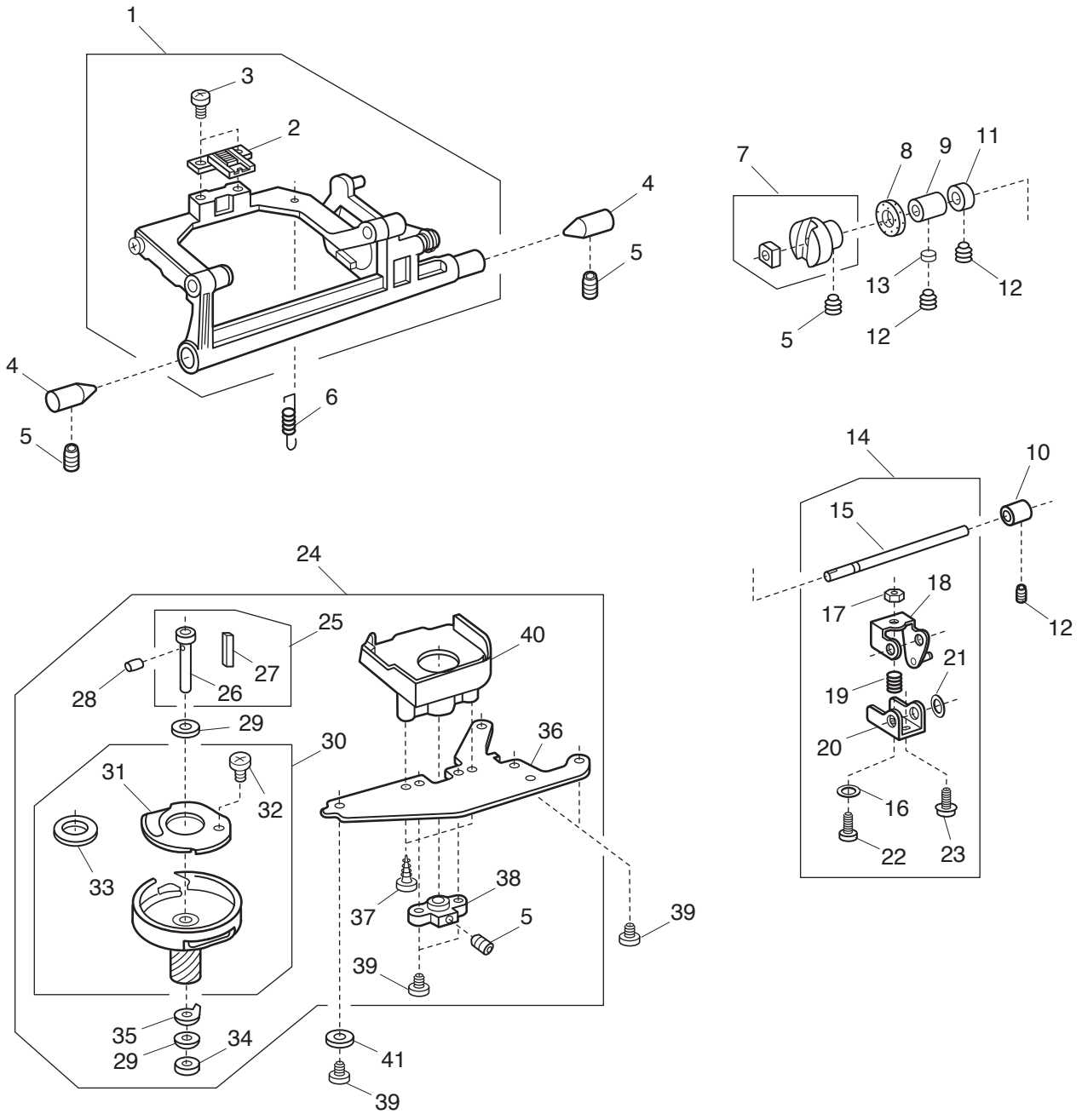

PARTS LIST

KEY NO.	PARTS NO.	DESCRIPTION
1	827615609	Feed lock shaft (unit)
2	840005003	Feed dog
3	000104005	Setscrew 3.5x8
4	738055008	Straight pin
5	000111304	Hexagonal socket screw 5x5
6	650085002	Feed base spring
7	625508101	Feed regulator (unit)
8	823110009	Felt
9	625144002	Feed shaft bushing (front)
10	650092002	Feed shaft bushing (rear)
11	820387000	Ring
12	000111201	Hexagonal socket screw 4x4
13	650175000	Cushion
14	840603100	Feed shaft (unit)
15	827042012	Feed shaft
16	000070506	Washer
17	000160102	Adjustable lock nut 4
18	825261002	Feed adjusting arm (2)
19	589040002	Spring
20	827043105	Feed adjusting arm (1)
21	810207004	Spring washer
22	827086007	Feed adjusting arm screw
23	000115906	Setscrew TP 3x12
24	827614055	Shuttle race (unit)
25	827632004	Shuttle race shaft (unit)
26	820123006	Shuttle race shaft
27	820124007	Oil string (1)
28	820125008	Oil string (2)
29	000038409	Washer
30	650623307	Shuttle body (unit)
31	627191000	Hook bottom plate
32	820374004	Setscrew 2x2.3
33	627190010	Magnet
34	625102008	Washer
35	627192001	Washer
36	823106002	Shuttle race set plate
37	000161309	Setscrew 3x12 (B)
38	650094004	Shuttle race shaft base
39	000081005	Setscrew 4x8
40	827040009	Hook gear cover
41	000070506	Washer 4

PARTS LIST

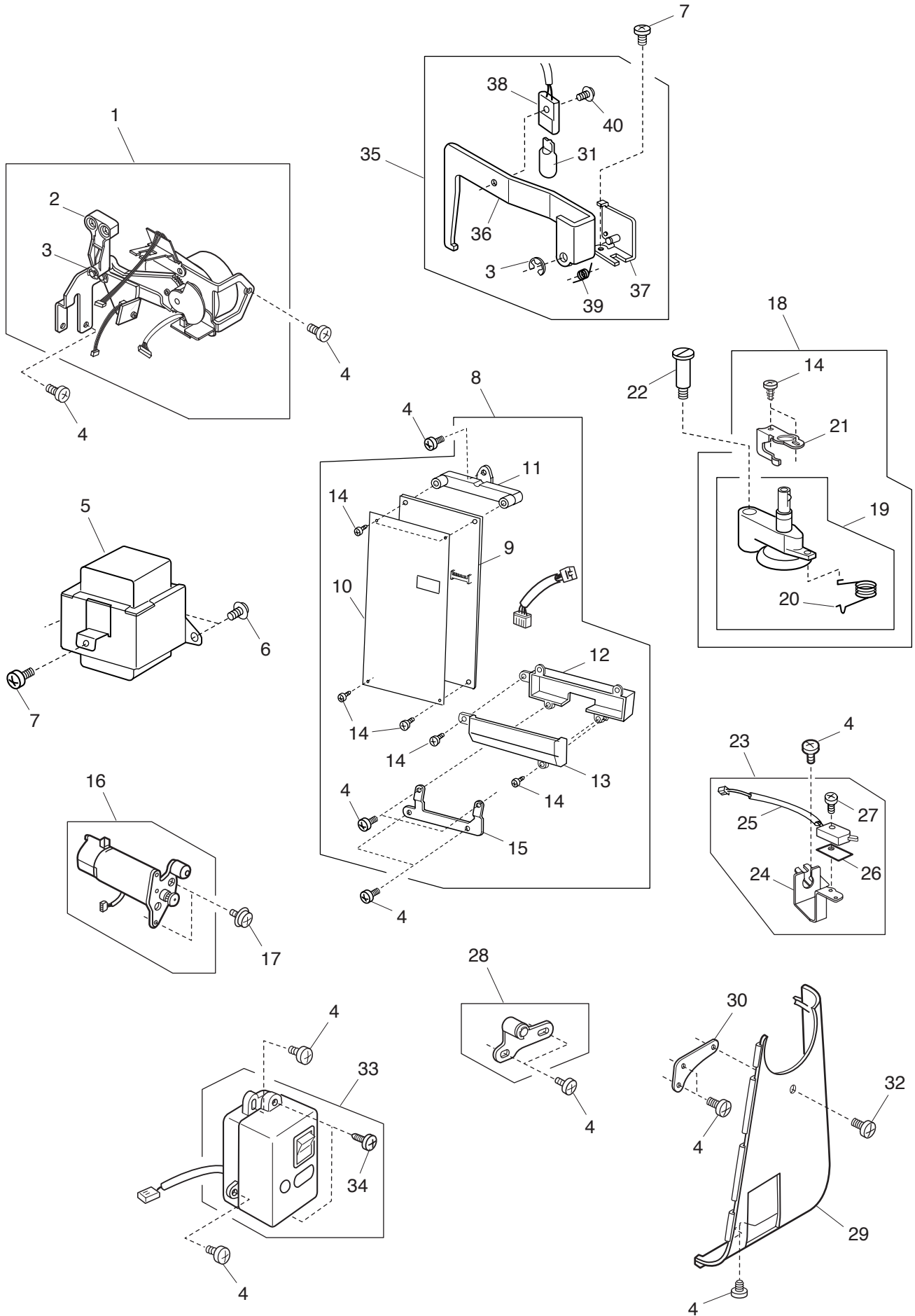

PARTS LIST

KEY NO.	PARTS NO.	DESCRIPTION
1	844605001	Zigzag width motor (unit)
2	844052007	Connecting body
3	000002105	Snap ring E-3
4	000081005	Setscrew 4x8
5	846512109	Power transformer (unit)
6	000115205	Setscrew TP 4x6
7	000101404	Setscrew 4x6
8	844627205	Printed circuit board A (unit)
9	844518202	Printed circuit board A (unit)
10	844072003	Printed circuit board A insulation paper
11	848014009	Printed circuit board A set plate (upper)
12	846184005	Printed circuit board A case
13	846185006	Printed circuit board A case lid
14	000120203	Setscrew 3x8 (B)
15	848017002	Printed circuit board A supporter
16	843615104	Motor (unit)
17	000115700	Setscrew TP 4x10
18	844628033	Bobbin winder (unit)
19	827506008	Bobbin winder (unit)
20	823119008	Bobbin winder spring
21	844075039	Clutch releasing plate
22	652093009	Setscrew
23	844629001	Bobbin winder switch (unit)
24	844076007	Bobbin winder switch set plate
25	852510209	Micro switch (unit)
26	852014002	Insulation paper
27	000041209	Setscrew 1.7x6
28	652611009	Idler (unit)
29	828064002	Belt cover
30	827085017	Belt cover set plate
31	000026002	Wedge base lamp 12V 5W
32	000104119	Setscrew 4x20
33	843519200	Receptacle (unit)
34	000121204	Setscrew 4x8 (B)
35	844646004	Lamp (unit)
36	844107008	Lamp set plate
37	849055005	Lamp base plate
38	843508103	Lamp socket (unit)
39	849056006	Lamp base plate spring
40	000115308	Setscrew TP 2x8

PARTS LIST

1

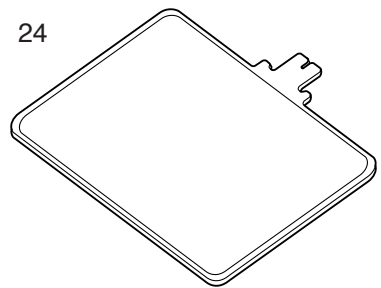
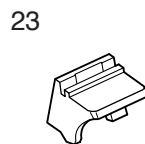
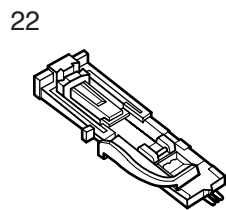
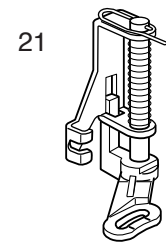
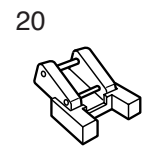
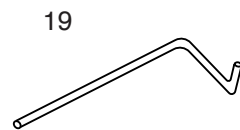
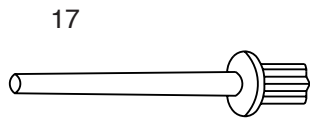
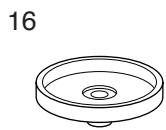
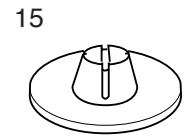
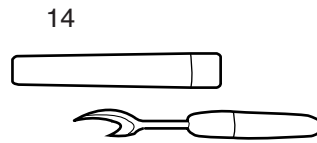
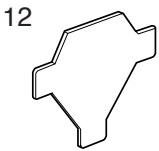
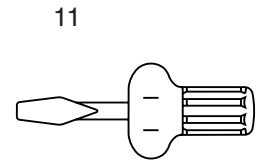
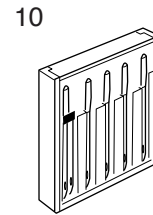
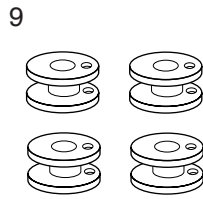
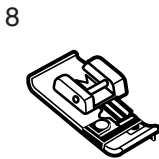
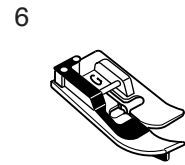
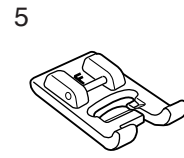
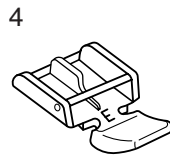
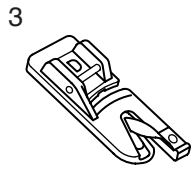
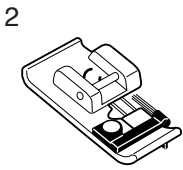

25

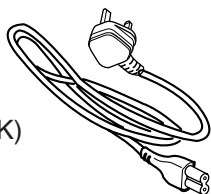

(UK)

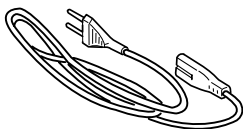

(Continental Europe)

26



27

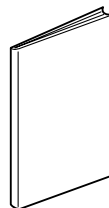

28

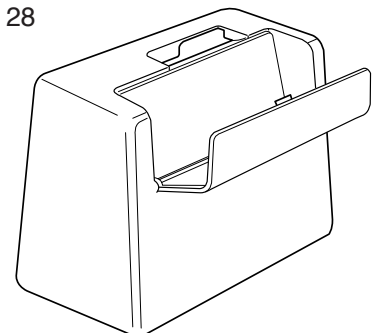

PARTS LIST

KEY NO.	PARTS NO.	DESCRIPTION
1	844870009	Accessory set
2	822801001	Overedge foot
3	820809014	Hemmer foot
4	829801002	Zipper foot
5	822804118	Satin foot
6	825817009	Blind hem foot
7	820819006	Cording foot
8	822808008	Overlock foot
9	102261103	Bobbin
10	820827007	Needle case (unit)
11	820832005	Large screw driver
12	653802002	Screwdriver
13	802424004	Lint brush
14	560406104	Seam ripper
15	822019509	Small spool holder
16	829803004	Spool stand
17	625031500	Additional spool pin
18	102403109	Felt
19	802422002	Quilter
20	802406011	Button foot
21	822820006	Basting foot
22	753801015	Automatic buttonhole foot
23	842808000	Quick reference chart base
24	842809609	Quick reference chart
25	830377008	Power supply cord (UK)
	830335004	Power supply cord (Continental Europe)
26	043271133	Foot control
27	844800020	Instruction book (English)
	844800019	Instruction book (Dutch/French/German)
	844800053	Instruction book (Norwegian/Swedish/Danish)
	844800064	Instruction book (Italian)
28	478703302	Cover